

**V BELT CONVEYOR + V FEEDER KIT**

---

**EFFICIENCY AND RELIABILITY  
FOR TODAY'S FARMS**

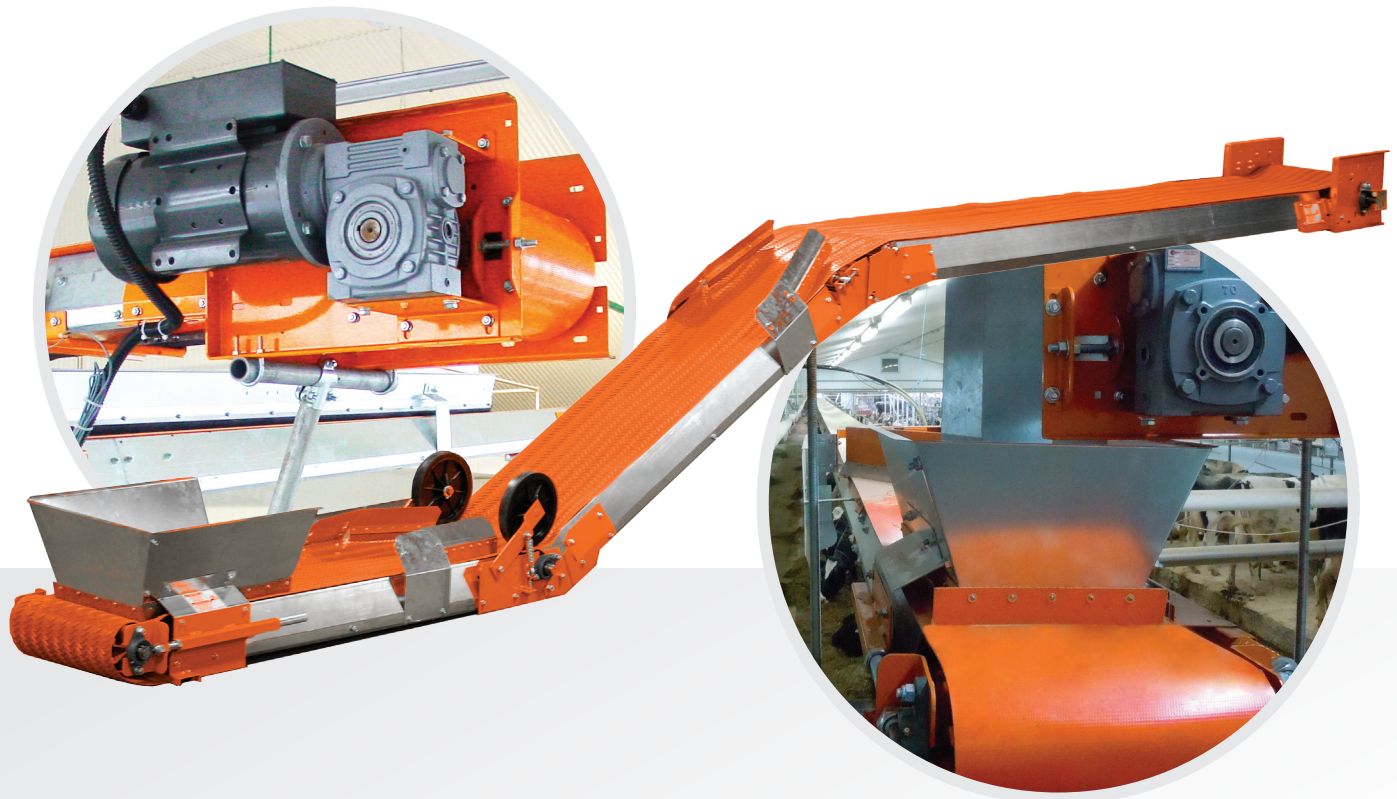

**VALMETAL**  
valmetal.com

# TRANSPORT FEED WHERE YOU WANT



MADE OF  
GALVANIZED STEEL

Valmetal belts are available in 2 models:

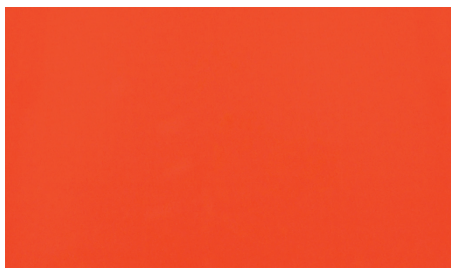

## SMOOTH BELT (10° MAXIMUM INCLINED)

Indoors and outdoors. A tough polyester belt with P.V.C. coating maintains flexibility in sub-zero weather for year round performance. Concave belt provides high volume conveying capacity, uniform delivery and no feed separation.

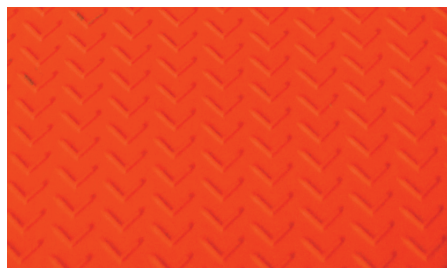

## TEXTURED BELT (30° MAXIMUM INCLINED)

In the case of steep incline slopes, we recommend using the textured belt, providing more traction.

## SENSOR

Allows to check the effective rotation of the conveyor drive in case of **automated feeding**. ▲

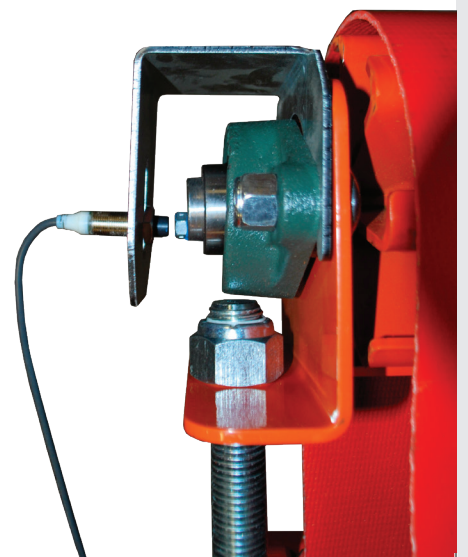

# TEN DIFFERENT MODELS TO CHOOSE FROM PLUS LOTS OF ACCESSORIES TO FIT YOUR NEEDS.

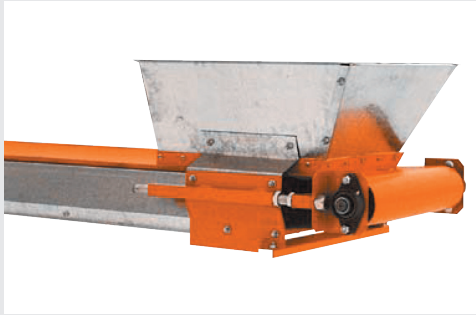

## HOPPER

Galvanized steel hopper eliminates spillage and centers feed on belt. Simple belt tightener maintains belt tension.



OPTIONAL

## DECLINE SECTION

A decline section, adjustable from 0° to 35° to fit different configurations. Deflectors keep feed in the center of the belt.



OPTIONAL

## INCLINE SECTION

An adjustable incline section, from 0° to 35° makes installation easy. The big UHMW hold down wheels will not corrode and requires no lubrication. The adjustable scrapers deflect feed away from under the wheels.

## SCRAPER OR BRUSH



OPTIONAL

## POWER BRUSH

The large counter rotating brush is recommended with textured belt to remove fines.

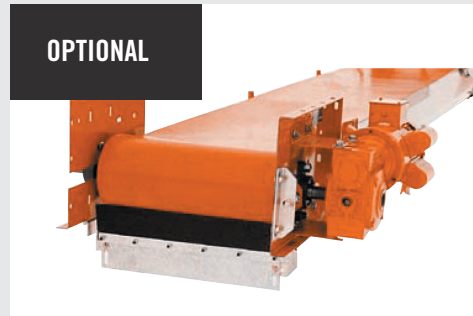

OPTIONAL

## BELT SCRAPER

For clean removal of fines on standard belt.

## PLOW

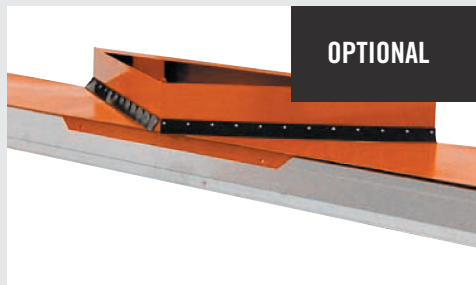

OPTIONAL

## TWO WAY PLOW

For the reversible conveyor, the two way plow can be placed anywhere on the conveyor to deviate feed off the belt. It allows feed to pass when tipped up. May be operated from a remote location with cable and pulley (not included). **Use with smooth belt only.**



OPTIONAL

## STATIONARY PLOW

The stationary plow can be placed anywhere on the conveyor to deviate feed off the belt. It allows feed to pass when tipped up. May be operated from a remote location with cable and pulley (not included). **Use only with smooth belt.**

## RELIABLE

Conveyor reliability begins with the drive unit. The Valmetal conveyors feature an industrial gear box drive system designed to last longer with less maintenance, so you can count on more years of trouble free operation. The large diameter lagged drive pulley offers slip-proof traction.

## DEPENDABLE PERFORMANCE

Concave belt provides high volume conveying capacity, uniform delivery and no feed separation. Made for indoor/outdoor use, the Valmetal polyester belt with PVC coating maintains flexibility in sub-zero weather for year round performance.

## FLEXIBILITY

Reversible, to convey in either direction. Standard belt conveys level and up moderate inclines (up to 10°) and textured belt allows conveying up steeper inclines (up to 30° elevation)

## AVAILABLE ACCESSORIES FOR ANY KIND OF INSTALLATION

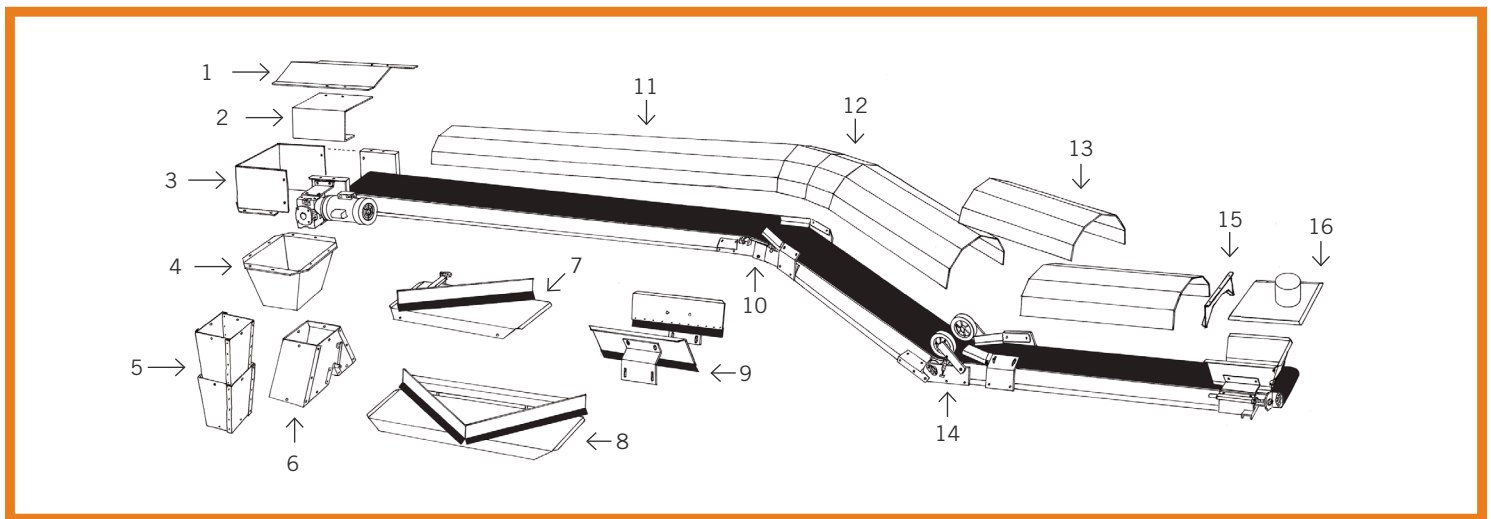

1 Drive unit and head spout cover

2 Motor guard

3 Conveyor head spout. Direct feed down.

4 Spout extension adaptor

5 Spout extensions

6 Diverter

7 Stationary plow to discharge feed off the belt. (Use only with smooth belt)

8 Two-way stationary plow, for reversible conveyor

9 Flow thru hopper. For several loading points

10 Decline section

11 Cover for wind and weather protection

12 Decline section cover

13 Incline section cover

14 Incline section

15 Cover transition. Use to join the hopper cover to the section cover.

16 Hopper cover to be used with polyethylene tube

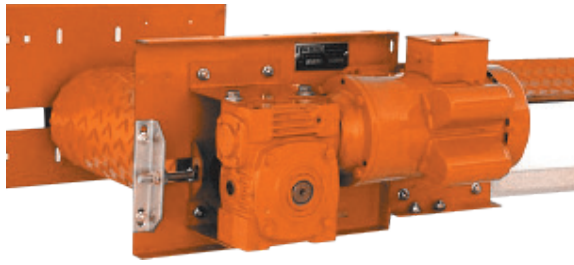

The motor and gear box can be mounted on either side of the conveyor. The low profile design offers more flexibility of mounting installation.



### PORTABLE CONVEYOR

The inclined angle is adjustable to perfectly fit your needs (max. 30°)

## SPECIFICATIONS

In case of very long conveyor or long reversible conveyor, Valmetal offers and recommends dual drive system. In doubt, ask Valmetal dealer.

Model	6014	6018	7014	7018	7024	7036	8014	8018	8024	8036
Max. length	50' 15 m	40' 12 m	120' 36,5 m	100' 30 m	70' 21 m	25' 8 m	260' 79 m	200' 61 m	120' 36,5 m	50' 15 m
HP requirement *	1 to 1 <sup>1/2</sup> Hp		1 <sup>1/2</sup> to 2 Hp		2 Hp		3 to 5 Hp			
Drive	Gear box to 5,5" (12,7 cm) diameter crowned and lagged pulley		Gear box to 6,5" (15,2 cm) diameter crowned and lagged pulley				Gear box to 8,5" (20,3 cm) diameter crowned and lagged pulley.			
Belt	Polyester fabric with PVC coating, smooth or textured, specially treated for cold weather.									
Width	14" 35,5 cm	18" 45,7 cm	14" 35,5 cm	18" 45,7 cm	24" 61 cm	36" 91 cm	14" 35,5 cm	18" 45,7 cm	24" 61 cm	36" 91 cm
Elevation	Up to 10° with smooth belt (2" - 5 cm per foot of section) Up to 30° with textured belt (6" - 15 cm per foot of section)									
Span	Up to 20' (6 m) between supports									
Conveyor sections	14" (35,5 cm) and 18" (45,7 cm) models : 16 gau galvanized 2,5' (76 cm), 4' (1,2 m), 5' (1,5 m), 8' (2,4 m), and 10' (3 m)					24" (61 cm) and 36" (91 cm) models: 14 gau galvanized 2,5' (76 cm), 4' (1,2 m), 5' (1,5 m), 8' (2,4 m), and 10' (3 m)				
Covers	20 gau. galvanized 5' (1,5 m) and 10' (3 m)									

Note: there is no easy formula to determine a conveyor power requirement. It may substantially vary, depending upon weather, elevation, material to convey and accessories (i.e. incline section, etc.). In doubt, ask Valmetal expert !

## DIMENSIONS

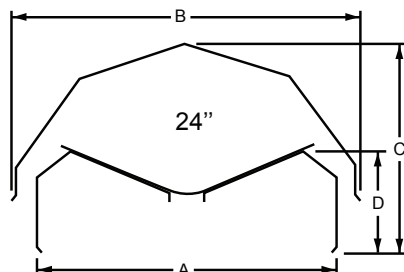
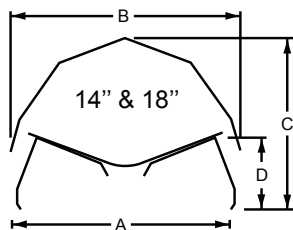

	14" 35,5 cm	18" 45,7 cm	24" 61 cm
A	15 <sup>15/16"</sup>	19 <sup>1/16"</sup>	26 <sup>3/8"</sup>
B	15 <sup>15/16"</sup>	19 <sup>7/8"</sup>	30 <sup>3/16"</sup>
C	13 <sup>5/18"</sup>	14 <sup>7/8"</sup>	18 <sup>1/4"</sup>
D	6 <sup>5/16"</sup>	6 <sup>5/16"</sup>	8 <sup>13/16"</sup>



# FEEDER KIT

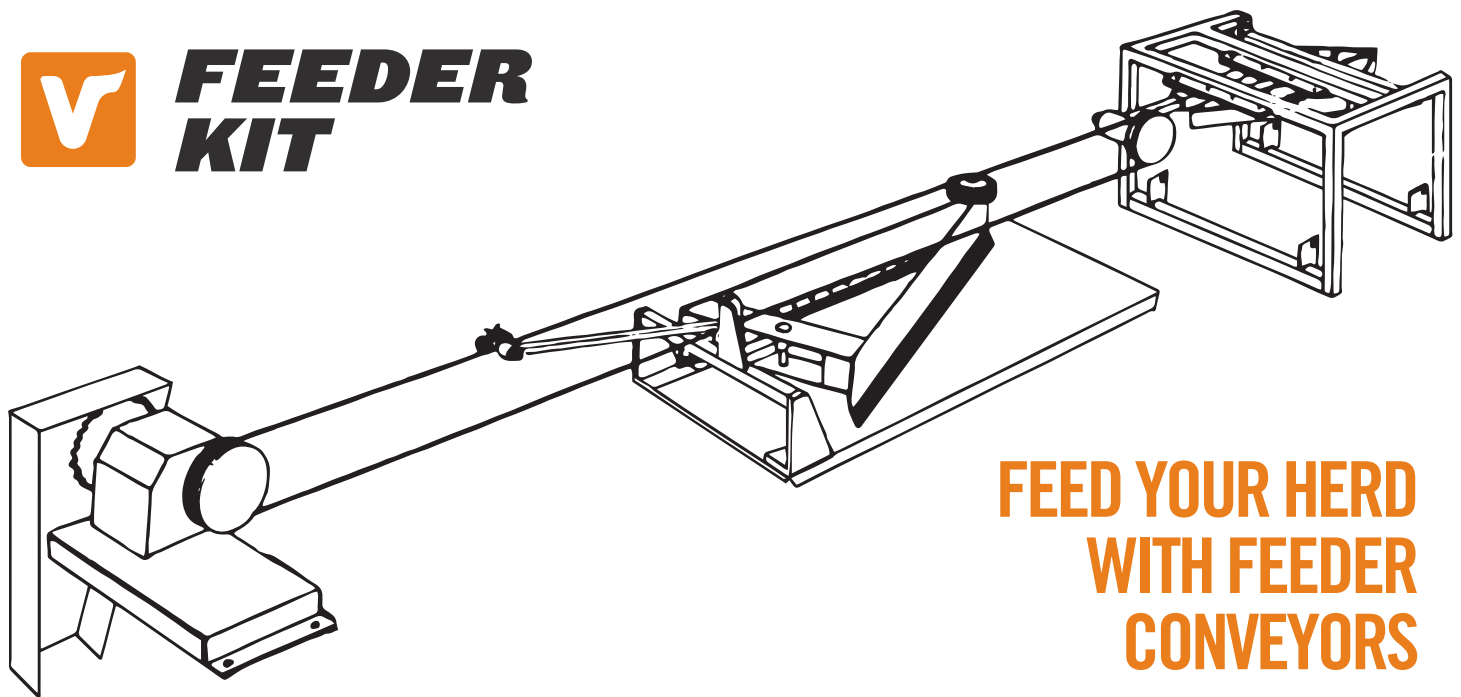

## FEED YOUR HERD WITH FEEDER CONVEYORS

Valmetal belt conveyors allow you to feed your herd with an automated feeding system using our feeder kit.

### HIGH CAPACITY SYSTEM FOR A QUICK AND CONTROLLED FEEDING

### FULLY CUSTOMIZABLE, FOR ANY KIND OF BARN CONFIGURATION

The valmetal feeder conveyor allows you to feed your herd with exceptional quality feed thanks to its ingenious operation, the low maintenance requirement and high level efficiency. From the mixer to the cow, the TMR keeps its uniformity and its consistency. All forage, grains, protein supplements, vitamins and minerals remain mixed as during the unloading, regardless of the length of the travel. The cow is not able to sort out individual ingredients and must eat the very important, but less tasty roughage, along with the rest of the ration.

No matter where the conveyor is installed, (inside or outside), above mangers or suspended from the ceiling, Valmetal feeder conveyors offer flexibility and efficiency, while ensuring an uniform feeding.

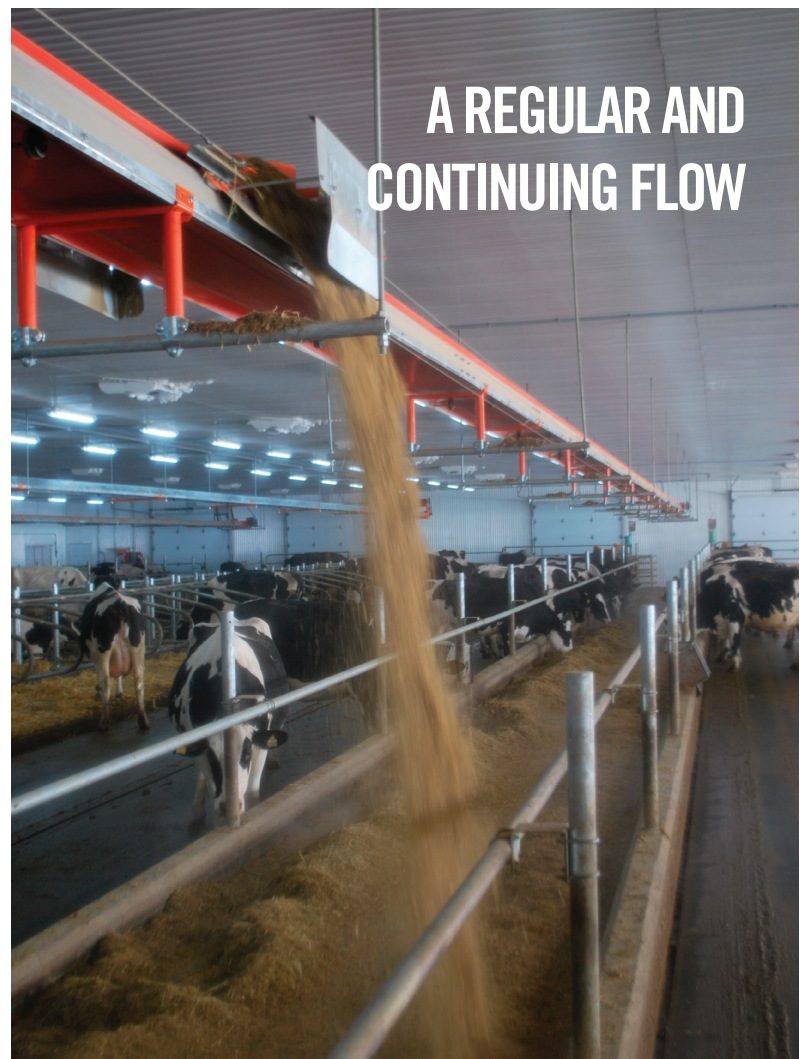

A REGULAR AND  
CONTINUING FLOW

## REGULAR FEEDER KIT

On the regular model, only one motor is required to drive belt and plow. The conveying belt moves quickly in one direction while a plow drops feed in the bunk. The plow reverses at each end of the feeder automatically and smoothly with the reliable continuous loop cable drive. To provide split-lot feeding the length of the bunk, a mechanical “tripper” switches the feed diverter automatically every complete revolution of the plow. This model can feed up to 200’ (61 m) length.

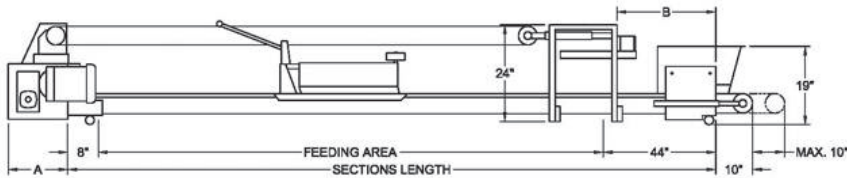

## LOW PROFILE FEEDER KIT

The low profile model provides the same characteristics and benefits; in addition, it features an independent plow drive system with an instant reversing motor, which allows delivery of different rations to different groups of cattle. Its design makes it the ideal feeder for in-barn installation. Suspended from the ceiling, it requires only 14" (35,5 cm).

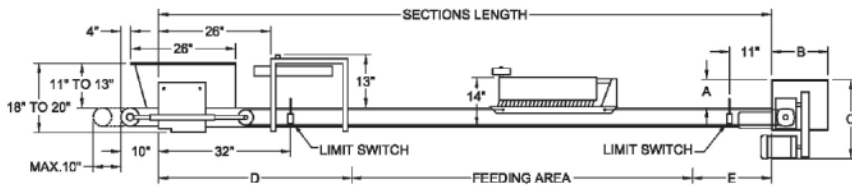

## ALSO AVAILABLE

### CENTER FEED BELT FEEDER KIT (NON ILLUSTRATED)

### LOW PROFILE FEEDER - 4 WAYS

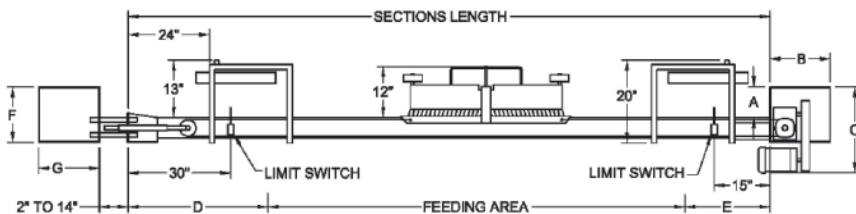

## HOW DOES THE FEEDER KIT WORK ?

No matter the feeder kit, the Valmetal belt slides on a “plate” driven by an industrial quality steel cable (impregnated with polypropylene) and the ration is plowed off the belt, on the right or the left of the conveyor.



## HOW DOES THE VALMETAL TRIPPER WORK ?

The plow, at every complete revolution, contacts the tripper and changes from one side to the other allowing to feed the opposite side of the conveyor.

# OPTIONS

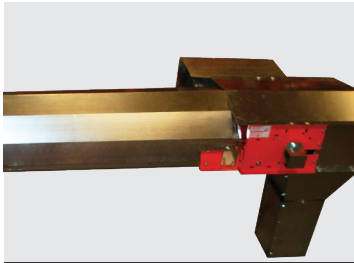

## OUTSIDE COVER

Made of galvanized steel, it protects the food and the conveyor from wind or rain (for belt conveyors).

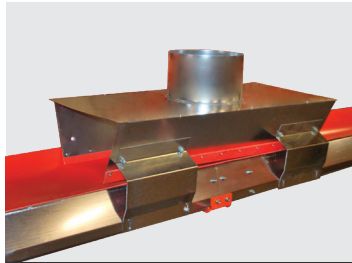

## HOPPER FOR SEVERAL LOADING POINTS

It allows a central loading in case of center feed kit.



## WINDBOARDS AND COVER

Made of galvanized steel, it protects the food and the conveyor from wind or rain (for feeder conveyor)

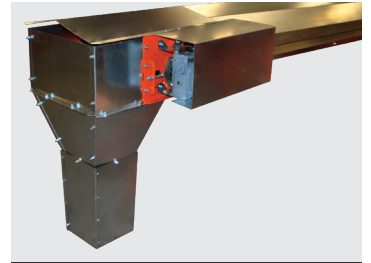

## UNLOADING SPOUT

Made of galvanized steel, a model is also available with a double diverter.

# ALSO AVAILABLE

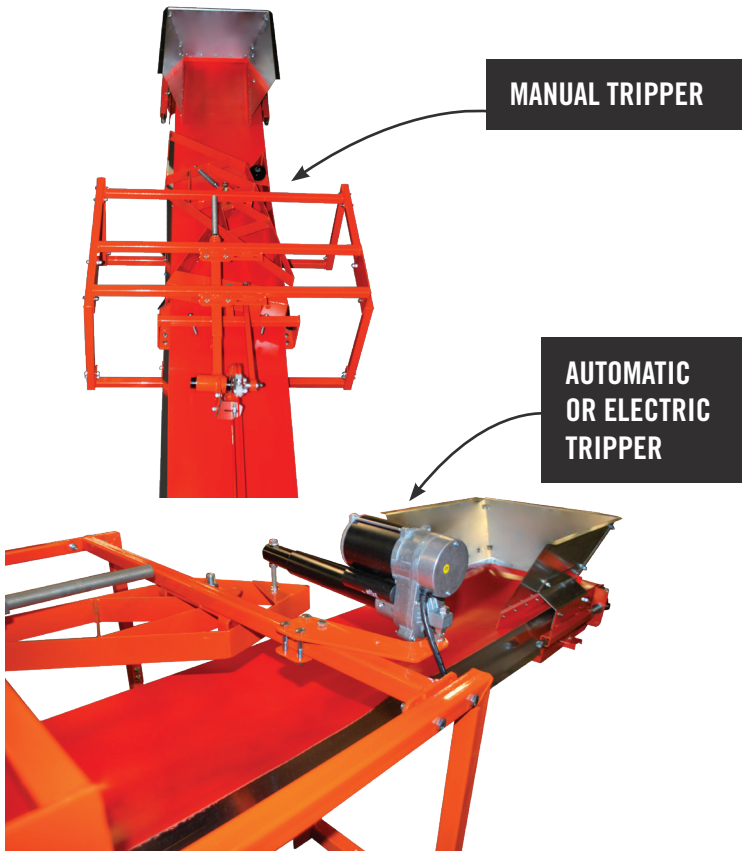

Based on legendary Valmetal reliability, all our conveyors bring together simplicity of operation with the most advanced mechanical and electronic engineering. Using the highest quality steel, Valmetal engineers work hard to make machines that stand the test of time, in the toughest conditions.

30 years of manufacturing experience, extensive testing and producer input have culminated in the most efficient feeding solution, the Valmetal feeder conveyor. This type of automated feeding system is engineered to the highest specifications of design and strength to ensure the maximum working life.

Specifications, descriptions and illustrative material in this literature are as accurate as known at the time of publication, but are subject to change without prior notice. Illustrations may include optional equipment and accessories, and may not include all standard equipment.

YOUR LOCAL DEALER:

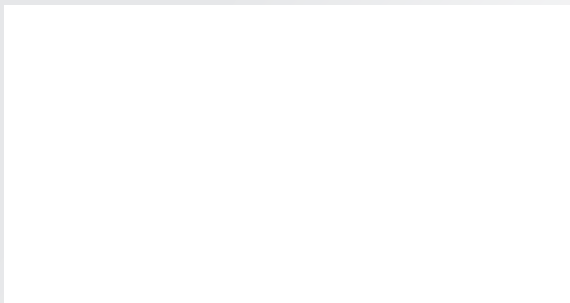

**VALMETAL**  
valmetal.com

Tel : 819 395-4282 • Fax : 819 395-2030 • info@valmetal.com